



Sun-Tek Manufacturing, Inc.
 10303 General Drive
 Orlando, FL 32824
 407 / 859-2117
 www.Sun-Tek.com
 CustomerService@Sun-Tek.com

INSTALLATION INSTRUCTIONS POLYCARBONATE SERIES

MODEL CMA

SIZES 1414, 1422, 1430, 1919, 2222, 2230

Use on any type roof (curb required)

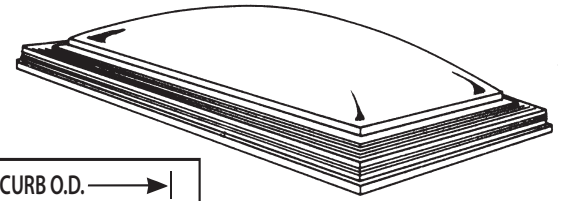

SIZE INFORMATION					Fastener Schedule	
Size Code	Roof Opening	Finished Opening (Drywall Dimension)	Models CM & CMA only Curb Outside Dimension	Fits on Center Spacing	Fastener Per Short Side	Fastener Per Long Side
1414	14½"x14½"	13½"x13½"	17½"x17½"	16"	3	3
1422	14½"x22½"	13½"x21½"	17½"x25½"	16" or 24"	3	3
1430	14½"x30½"	13½"x29½"	17½"x33½"	16"	3	3
1919	19½"x19½"	18½"x18½"	22½"x22½"	24"	3	3
2222	22½"x22½"	21½"x21½"	25½"x25½"	24"	3	3
2230	22½"x30½"	21½"x29½"	25½"x33½"	24"	3	3

CM, CMA is made 1" larger than outside dimension to allow for flashing.
 (Example: CM2246 Actual Skylight I.D. 26½" x 50½")

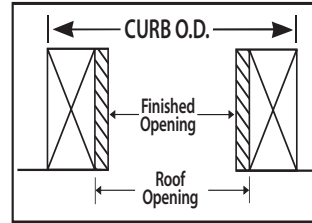

You will need:

- hammer
- keyhole saw
- skill saw
- nails
- drill
- 2 x 4's
- sealant/mastic
- tape measure
- chalkline or straight edge
- trowel or caulk gun
- utility knife

For Light Tunnel:

- 8 or 10 penny nails
- plywood or drywall

RECOMMENDED SEALANTS:

- 100% Silicone
- Sealants approved for use on polycarbonate (contact Sun-Tek)
- STS 1000 (or equivalent) Butyl rubber sealant/caulk

FAILURE TO FOLLOW RECOMMENDED INSTALLATION PROCEDURES MAY VOID WARRANTY

Please read instructions completely before beginning. Deck and roofing felt should already be installed.

All installation information is supplied in good faith, but without recommendation to its use. No guarantee of the results of any use of this information is to be implied, since conditions of use are beyond our control. Please consult local building codes for compliance before installing.

- Inspect skylight for damage before installing. Peel back protective plastic to inspect dome. If skylight is damaged, do not install. Please contact your supplier for information on a replacement.
- To properly position skylight between trusses/rafters, locate the roof opening from the underside of the decking. Drill holes or drive nails to mark corners. (If this area is not accessible, locate the ceiling joists from inside the house, mark and cut opening in ceiling, then mark roof opening.)
- Remove shingles 6 - 8" out from roof opening. Before cutting roof opening, check measurements against size chart. Snap a chalkline from corner to corner, or draw line with a straightedge, then cut roof opening.
- Frame roof opening using 2 x 4's as headers - cut two 2 x 4's to fit the actual distance between trusses / rafters and nail into place.
 - If applicable, cut ceiling opening and build tunnel framing. See "Light Tunnel Installation Instructions."
- Build curb (or use Sun-Tek's pre-built, pre-flashed insulated "Labor Saver" Curb- *Not for metal roofs*)
 - Construct curb with 2x4's, 2x6's, etc. (depending on height desired or building code requirements). Curb should be minimum 3½" high. Be sure inside measurement of curb is the same as roof opening measurement.
 - Secure curb to roof per local building codes. Build curb as shown in drawing. This is the tested/approved method.
- Shingle roof up to bottom of curb.
- Flash curb (or use Sun-Tek's pre-formed, pre-cut Step Flash Kit with one-piece head and sill- *Not for metal roofs. Step flash for 2x4 curb only!*). Use galvanized sheet metal, aluminum, or copper. Metal should extend a minimum of 4" over shingles (on bottom side), then up sides of curb. Flashing should be flush with curb top. Flash curb to comply with Florida building code.
- Shingle up sides and across the top.
- Apply a ½" wide bead of caulking on top of the curb around the entire perimeter. Sealant applied too close to the opening may "ooze" into the opening. Can also use 1" wide by 1/8" thick butyl tape, if compatible.
- Set skylight over opening with the "THIS EDGE DOWN" label at the bottom of the opening. Nail into place through the pre-drilled

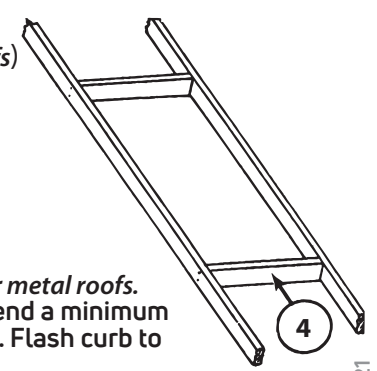
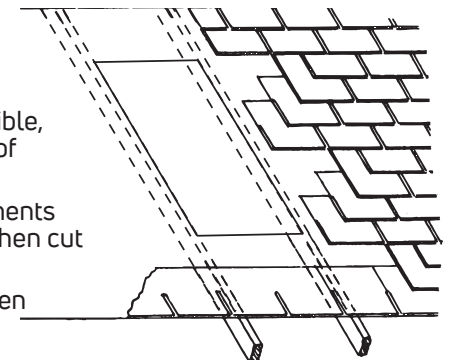

holes with the #8 x 1 3/4" galvanized ring-shanked roofing nails provided (See Fastener Schedule).

11. Interior Finishing: Run drywall (or other finishing material) up the inside face of the curb.

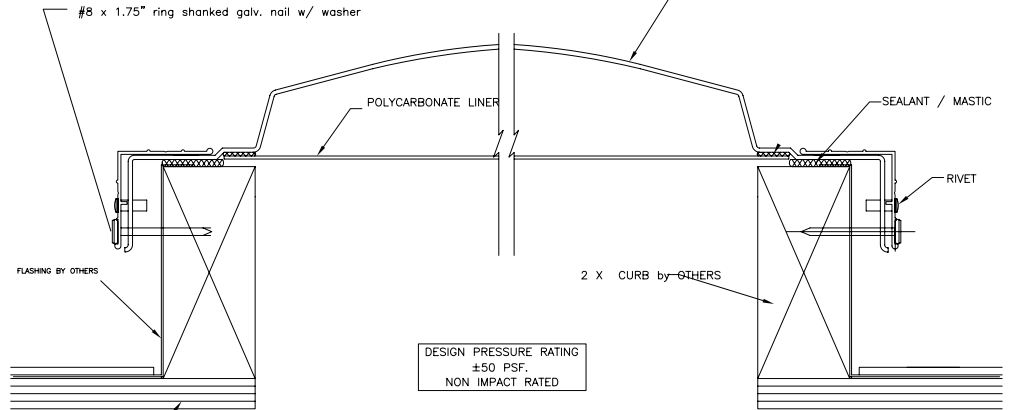
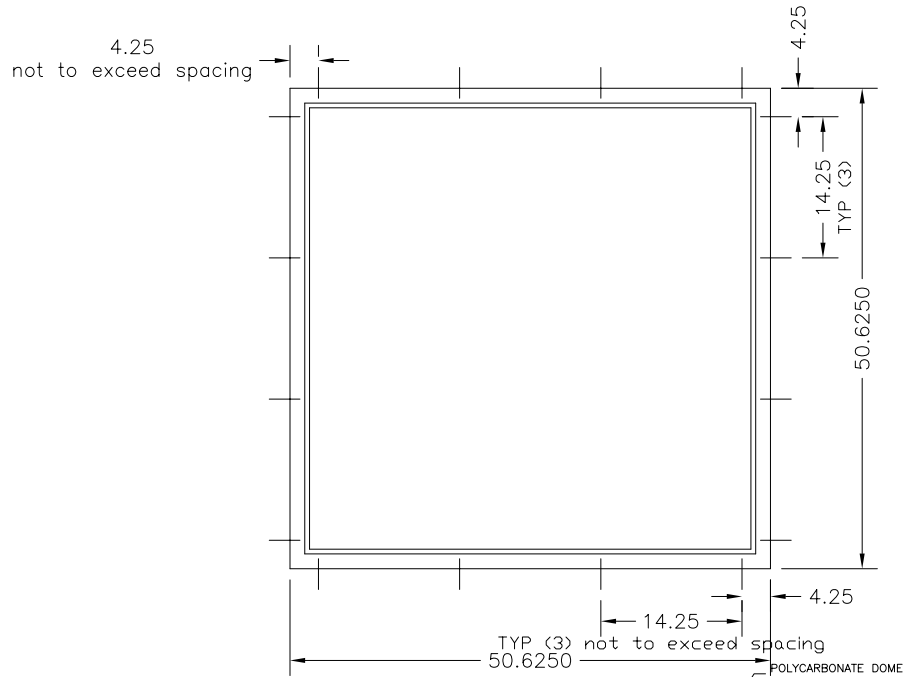
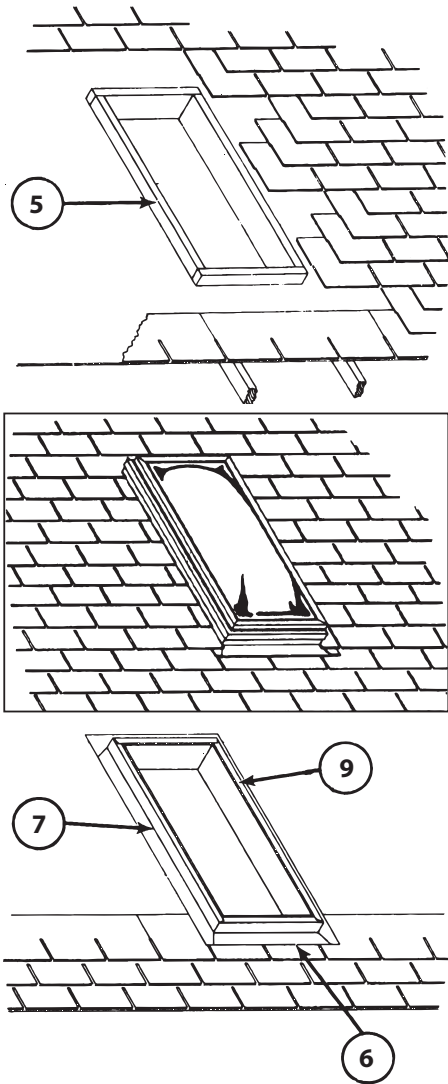

CLEANING YOUR SKYLIGHT:

Use a mild dish soap (such as Dawn Liquid) and a clean sponge or soft cloth. Fresh paint splashes, glazing compound, etc. may be removed before drying by rubbing lightly with a soft cloth or cotton ball soaked in isopropyl alcohol. DO NOT use abrasive or highly alkaline cleaners, ammonia, benzene, gasoline, acetone, or carbon tetrachloride. Do not clean skylight in bright sun or high temperatures. Periodic waxing with a high quality, non-abrasive wax such as Mirror-Glaze will help maintain the good looks of your skylight.

LIGHT TUNNEL INSTALLATION INSTRUCTIONS

For homes with an attic, it is necessary to build a tunnel between skylights and ceiling. The tunnel walls may be straight, or flared for extra light and architectural appeal. It's very easy to increase the tunnel size along the length of the ceiling joists. As long as no roof-supporting members are cut, no special framing is needed. While it is possible to flare the tunnel in all directions, if support members are cut, special framing will be required for structural support. In this case you must consult a qualified building professional to insure proper and safe results.

- 1 After roof and ceiling openings have been framed, measure distance (at each corner of roof opening) between rafter/truss and ceiling joist.
- 2 Using these four measurements, cut 2 x 4 lumber for vertical support members (two per corner).
- 3 In each corner, nail vertical support members into place at right angles to each other.
- 4 Measure, cut, and nail tunnel walls into place. Suggestions for lining tunnel:
 - use drywall, tape corners, and paint white using regular or texture paint. (Texture paint alone will hide and fill untaped joints, but in time, cracks may appear in corners.)
 - use prefinished paneling with molding in corners.
 - line the tunnel with cedar, pine, or a wood to coordinate with your decor.
 - for special effects, try painting the tunnel a striking accent color, or use mirrors or wallpaper on tunnel walls.
- 5 Caulk the slight gap between the tunnel walls and skylight base.
- 6 Finish off tunnel at ceiling with molding, or blend edges into ceiling with texture paint.
- 7 Be sure to wrap the exterior of the tunnel with insulation for energy savings.

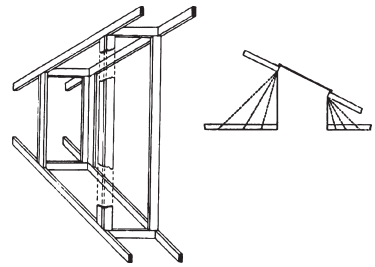

POLYDOME SKYLIGHT LIMITED WARRANTY

Sun-Tek Manufacturing, Inc. ("Sun Tek") 10303 General Drive, Orlando, Florida 32824, (407) 859-2117, warrants this Skylight on the following terms and conditions: A. Warranty Coverage: This warranty applies to both the original purchaser and first consumer-owner of a Skylight made by Sun-Tek. B. Warranty Duration: This warranty shall remain in effect for a period of five (5) years on Model SF and ten (10) years on all other Dura-Series models after the date the Skylight is purchased or the date the skylight is delivered to the first consumer-owner, whichever is later. One (1) year on electric components. C. Warranty Application: This warranty applies only to the materials and fabrication of the Skylight and does not apply to any defect or damage caused by improper use, improper installation, improper care, shipping damage or accident. This warranty does not cover any cosmetic changes in skylight, including but not limited to pitting, hazing, paint finish, discoloration. Condensation or damaged caused by condensation is not covered under this warranty. D. Performance by Sun-Tek: During the warranty period, Sun-Tek will provide free of charge an equivalent new skylight (or component thereof) for one found to be defective in material or workmanship. Shipping costs of such replacements are not the responsibility of Sun-Tek. Sun-Tek will not be responsible for any costs of removal or re-installation. E. Validation Procedure: To obtain performance under this warranty, the purchaser must: (1) On installed skylights, contact Sun-Tek for instructions before removing skylight. Removal of skylight from roof before inspection will void warranty. (2) Notify Sun-Tek in writing of any claim within thirty (30) days after the defect is discovered; (3) Sun-Tek or its authorized agents must examine high quality installed photographs of the subject skylight and determine to its satisfaction whether the defect is covered by this warranty; and (4) Present a copy of the receipt as proof of purchase. F. Implied Warranties: IMPLIED WARRANTIES, INCLUDING BUT NOT LIMITED TO IMPLIED WARRANTIES OF MERCHANTABILITY AND FITNESS FOR A PARTICULAR PURPOSE, SHALL NOT EXTEND BEYOND THE DURATION OF THE EXPRESS WARRANTIES PROVIDED HEREIN. Some states do not allow limitations on how long an implied warranty lasts, so the above limitation may not apply to you. G. Incidental or Consequential Damages: SUN-TEK SHALL NOT BE LIABLE FOR ANY INCIDENTAL OR CONSEQUENTIAL DAMAGES WHATSOEVER, INCLUDING BUT NOT LIMITED TO LOSS OF TIME OR REVENUE, DAMAGE RESULTING TO OTHER PROPERTY OR OTHER EXPENSES. Some states do not allow the exclusion or limitation of incidental or consequential damages, so the above limitation or exclusion may not apply to you. H. Exclusive Warranty: THIS WARRANTY IS EXCLUSIVE AND IN LIEU OF ALL OTHER WARRANTIES. This warranty gives you specific legal rights. You may have other rights which vary from state to state.