



Sun-Tek Manufacturing, Inc.
 10303 General Drive
 Orlando, FL 32824
 407 / 859-2117
 www.Sun-Tek.com
 CustomerService@Sun-Tek.com

INSTALLATION INSTRUCTIONS POLYCARBONATE SERIES

MODEL SF

SIZES 1414, 1422, 1430, 1919, 2222, 2230

* Minimum 3:12 pitch required

* For use on asphalt shingle roofs only!

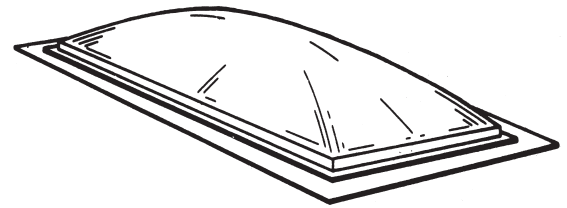

SIZE INFORMATION				Fastener Schedule	
Size Code	Roof Opening	Finished Opening (Drywall Dimension)	Fits on Center Spacing	Fastener Per Top & Bottom	Fastener Per Side
1414	14½"x14½"	13½"x13½"	16"	4	4
1422	14½"x22½"	13½"x21½"	16" or 24"	4	6
1430	14½"x30½"	13½"x29½"	16"	4	8
1919	19½"x19½"	18½"x18½"	24"	5	5
2222	22½"x22½"	21½"x21½"	24"	6	6
2230	22½"x30½"	21½"x29½"	24"	6	8

You will need:

- hammer
- keyhole saw
- skill saw
- nails
- drill
- 2 x 4's
- sealant/mastic
- tape measure
- chalkline or straight edge
- trowel or caulk gun
- utility knife

For Light Tunnel:

- 8 or 10 penny nails
- plywood or drywall

RECOMMENDED SEALANTS:

- 100% Silicone
- Sealants approved for use on polycarbonate (contact Sun-Tek)
- STS 1000 (or equivalent) Butyl rubber sealant/caulk

FAILURE TO FOLLOW RECOMMENDED INSTALLATION PROCEDURES MAY VOID WARRANTY

Please read instructions completely before beginning. Deck and roofing felt should already be installed.

All installation information is supplied in good faith, but without recommendation to its use. No guarantee of the results of any use of this information is to be implied, since conditions of use are beyond our control. Please consult local building codes for compliance before installing.

- Inspect skylight for damage before installing. Peel back protective plastic to inspect dome. If skylight is damaged, do not install. Please contact your supplier for information on a replacement.
- To properly position skylight between trusses/rafters, locate the roof opening from the underside of the decking. Drill holes or drive nails to mark corners. (If this area is not accessible, locate the ceiling joists from inside the house, mark and cut opening in ceiling, then mark roof opening.)
- Remove shingles 6 - 8" out from roof opening. Before cutting roof opening, check measurements against size chart. Snap a chalkline from corner to corner, or draw line with a straightedge, then cut roof opening.
- Frame roof opening using 2 x 4's as headers - cut two 2 x 4's to fit the actual distance between trusses / rafters and nail into place.
 - If applicable, cut ceiling opening and build tunnel framing. See "Light Tunnel Installation Instructions."
- Shingle up to the bottom of the roof opening.
- Apply a ½" wide bead of caulking, set back 1" from the roof opening around the entire opening. Set a second ½" wide bead around the entire opening, set 1" back from the first bead. Sealant applied too close to the opening may "ooze" into the opening. Can also use 3" wide x 1/8" thick butyl tape, if compatible. Set ½" back from opening.
- Set skylight over opening with the "THIS EDGE DOWN" label at the bottom of the opening. Nail into place through the pre-drilled holes in the flange with the 1¼" galvanized ring-shanked roofing nails provided (See Fastener Schedule). Cover the head of each nail with sealant. Place a ½" bead of sealant at the outside edge of the flange up both sides and across the top. Place a second bead on the flange set 1" in from the first bead.
- Shingle up sides and across the top. Place shingles as far in as possible, but be careful not to nail through the skylight flange.
- The bottom flange will still be exposed: we recommend leaving it this way. However, if you decide to place a "false shingle" over it, be careful not to nail through the flange.
- Interior Finishing: Run drywall (or other finishing material) up the inside face.

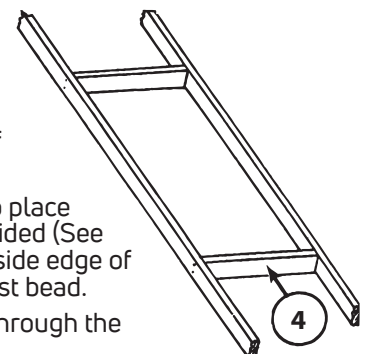
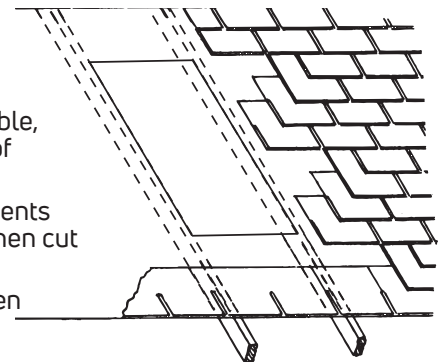

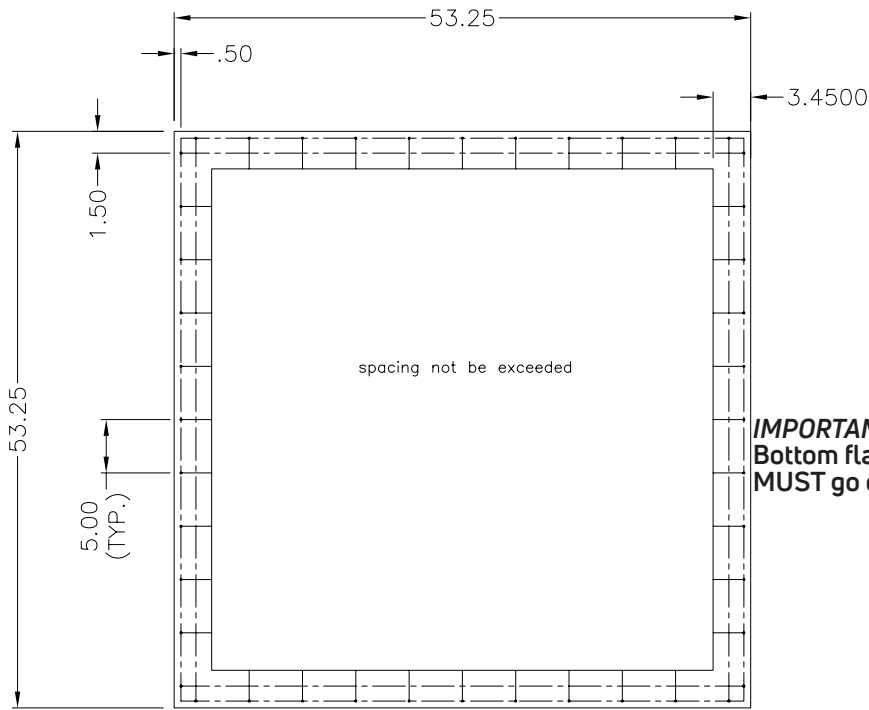

IMPORTANT:
Bottom flange of skylight
MUST go on top of shingles.

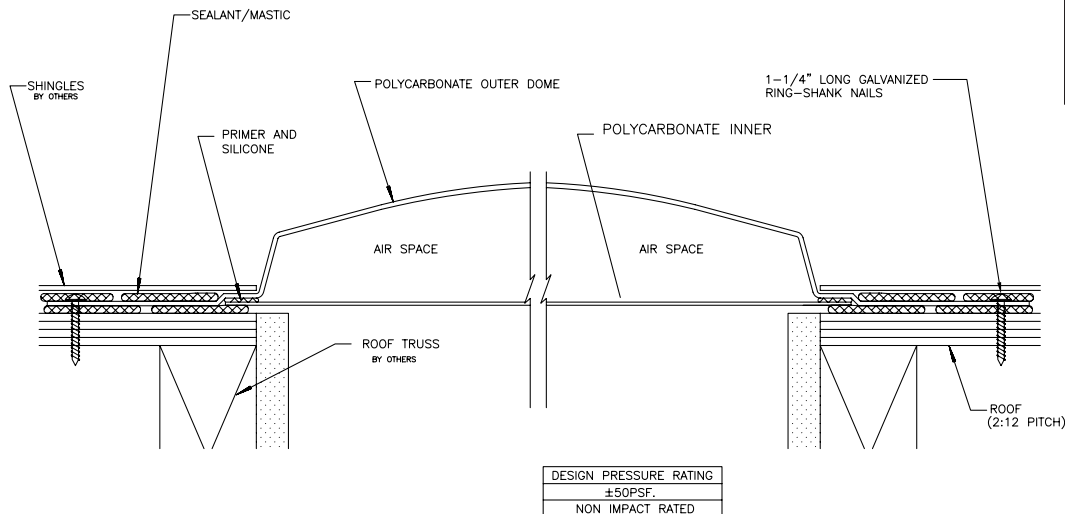
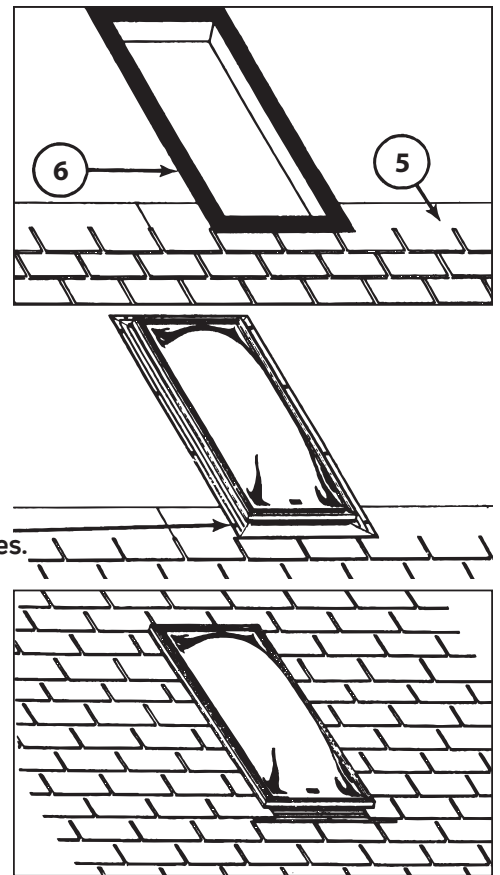

DESIGN PRESSURE RATING
±50PSF.
NON IMPACT RATED

CLEANING YOUR SKYLIGHT:

Use a mild dish soap (such as Dawn Liquid) and a clean sponge or soft cloth. Fresh paint splashes, glazing compound, etc. may be removed before drying by rubbing lightly with a soft cloth or cotton ball soaked in isopropyl alcohol. **DO NOT** use abrasive or highly alkaline cleaners, ammonia, benzene, gasoline, acetone, or carbon tetrachloride. Do not clean skylight in bright sun or high temperatures. Periodic waxing with a high quality, non-abrasive wax such as Mirror-Glaze will help maintain the good looks of your skylight.

LIGHT TUNNEL INSTALLATION INSTRUCTIONS

For homes with an attic, it is necessary to build a tunnel between skylights and ceiling. The tunnel walls may be straight, or flared for extra light and architectural appeal. It's very easy to increase the tunnel size along the length of the ceiling joists. As long as no roof-supporting members are cut, no special framing is needed. While it is possible to flare the tunnel in all directions, if support members are cut, special framing will be required for structural support. In this case you must consult a qualified building professional to insure proper and safe results.

- After roof and ceiling openings have been framed, measure distance (at each corner of roof opening) between rafter/truss and ceiling joist.
- Using these four measurements, cut 2 x 4 lumber for vertical support members (two per corner).
- In each corner, nail vertical support members into place at right angles to each other.
- Measure, cut, and nail tunnel walls into place. Suggestions for lining tunnel:
 - use drywall, tape corners, and paint white using regular or texture paint. (Texture paint alone will hide and fill untaped joints, but in time, cracks may appear in corners.)
 - use prefinished paneling with molding in corners.
 - line the tunnel with cedar, pine, or a wood to coordinate with your decor.
 - for special effects, try painting the tunnel a striking accent color, or use mirrors or wallpaper on tunnel walls.
- Caulk the slight gap between the tunnel walls and skylight base.
- Finish off tunnel at ceiling with molding, or blend edges into ceiling with texture paint.
- Be sure to wrap the exterior of the tunnel with insulation for energy savings.

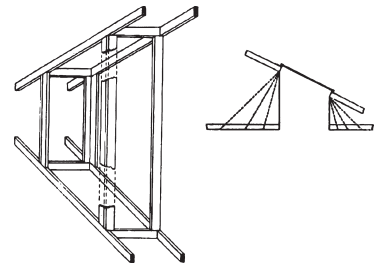

POLYDOME SKYLIGHT LIMITED WARRANTY

Sun-Tek Manufacturing, Inc. ("Sun Tek") 10303 General Drive, Orlando, Florida 32824, (407) 859-2117, warrants this Skylight on the following terms and conditions: A. Warranty Coverage: This warranty applies to both the original purchaser and first consumer-owner of a Skylight made by Sun-Tek. B. Warranty Duration: This warranty shall remain in effect for a period of five (5) years on Model SF and ten (10) years on all other Dura-Series models after the date the Skylight is purchased or the date the skylight is delivered to the first consumer-owner, whichever is later. One (1) year on electric components. C. Warranty Application: This warranty applies only to the materials and fabrication of the Skylight and does not apply to any defect or damage caused by improper use, improper installation, improper care, shipping damage or accident. This warranty does not cover any cosmetic changes in skylight, including but not limited to pitting, hazing, paint finish, discoloration. Condensation or damaged caused by condensation is not covered under this warranty. D. Performance by Sun-Tek: During the warranty period, Sun-Tek will provide free of charge an equivalent new skylight (or component thereof) for one found to be defective in material or workmanship. Shipping costs of such replacements are not the responsibility of Sun-Tek. Sun-Tek will not be responsible for any costs of removal or re-installation. E. Validation Procedure: To obtain performance under this warranty, the purchaser must: (1) On installed skylights, contact Sun-Tek for instructions before removing skylight. Removal of skylight from roof before inspection will void warranty. (2) Notify Sun-Tek in writing of any claim within thirty (30) days after the defect is discovered; (3) Sun-Tek or its authorized agents must examine high quality installed photographs of the subject skylight and determine to its satisfaction whether the defect is covered by this warranty; and (4) Present a copy of the receipt as proof of purchase. F. Implied Warranties: IMPLIED WARRANTIES, INCLUDING BUT NOT LIMITED TO IMPLIED WARRANTIES OF MERCHANTABILITY AND FITNESS FOR A PARTICULAR PURPOSE, SHALL NOT EXTEND BEYOND THE DURATION OF THE EXPRESS WARRANTIES PROVIDED HEREIN. Some states do not allow limitations on how long an implied warranty lasts, so the above limitation may not apply to you. G. Incidental or Consequential Damages: SUN-TEK SHALL NOT BE LIABLE FOR ANY INCIDENTAL OR CONSEQUENTIAL DAMAGES WHATSOEVER, INCLUDING BUT NOT LIMITED TO LOSS OF TIME OR REVENUE, DAMAGE RESULTING TO OTHER PROPERTY OR OTHER EXPENSES. Some states do not allow the exclusion or limitation of incidental or consequential damages, so the above limitation or exclusion may not apply to you. H. Exclusive Warranty: THIS WARRANTY IS EXCLUSIVE AND IN LIEU OF ALL OTHER WARRANTIES. This warranty gives you specific legal rights. You may have other rights which vary from state to state.